

# ADD Lounge System Outdoor



**Features:**

Versatile and flexible, ADD modular system has limitless combinations and can be transformed over time to accommodate any environment.

See Add Lounge System Components Specification for individual component dimensions.

**Options:**

- Waterproof protective cover

**Design:** FRANCESCO ROTA for LAPALMA

**Warranty:** 5 years

**Certifications:** FSC

**Awards:** German Design Award Special 2016, Reddot Award Winner 2016, ADI Index Design, Compasso d'Oro ADI 2016 - honourable mention

**Finishes:**

Upholstery in fabric collections Natte (cat B), Iris (cat B) or Lapalma Smart (cat C)

Refer to Lapalma Finishes Specification

Powder coat base: Black or white

HPL Fenix 40DIA pivoting top, tray, magazine rack and box for sockets.

HPL Fenix top

**Powder Coat:**



Black

White

**HPL Fenix:**



Black

White

Grigio Londra

Rosso Jaipur

## Configurations

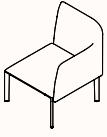

**One Seater**

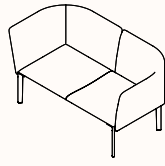

**Two Seater**

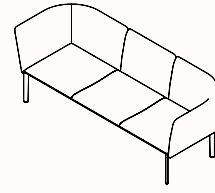

**Three Seater**

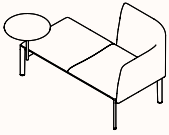

**Classic Mini**

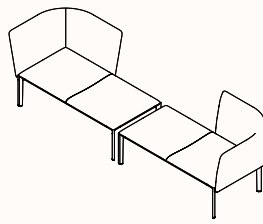

**Classic Mini - Double**

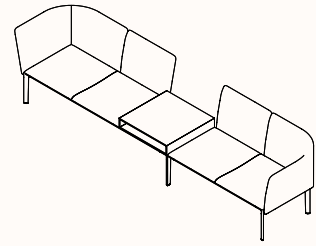

**Side by Side**

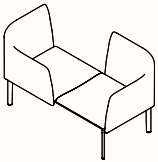

**Vis-a-vis Small**

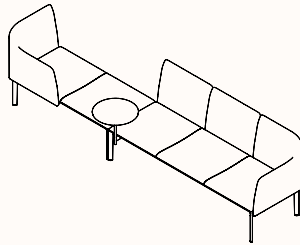

**Vis-a-vis Big**

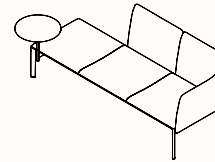

**Classic**

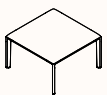

**Stool**

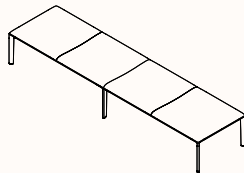

**Bench**

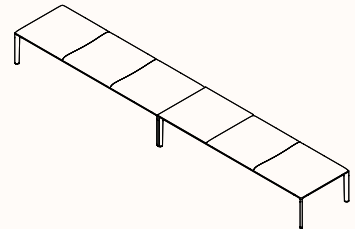

**Long Bench**

## Configurations

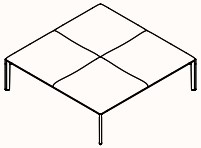

**Square Bench**

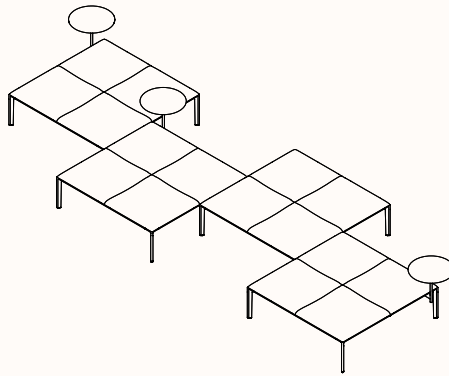

**Square Bench System**

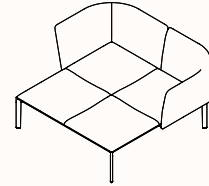

**Lounge**

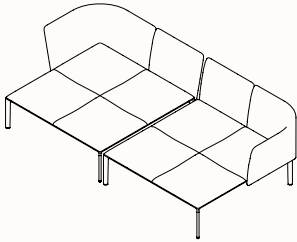

**Lounge - Double**

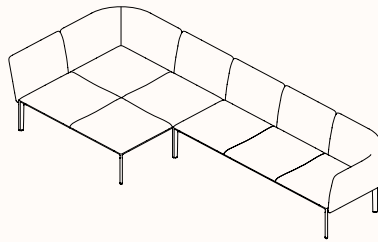

**Sofa**

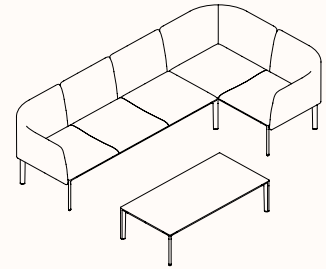

**L-Shape**

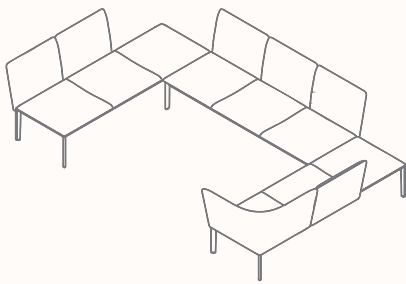

**C-Shape**

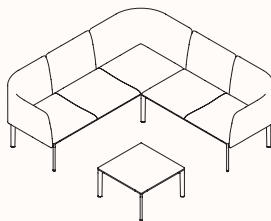

**L-Shape Big**

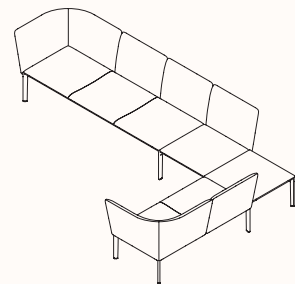

**L-Shape Open**

## Configurations

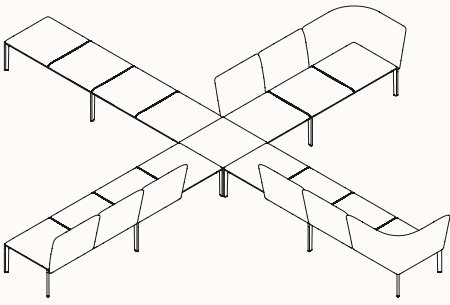

**X-Shape**

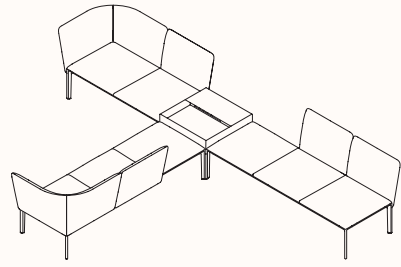

**T-Shape**

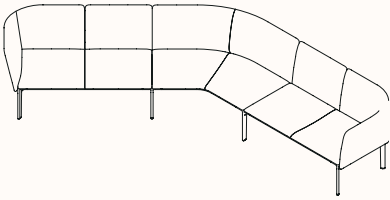

**V-Shape In**

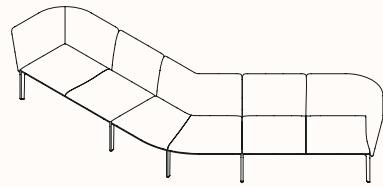

**V-Shape Out**

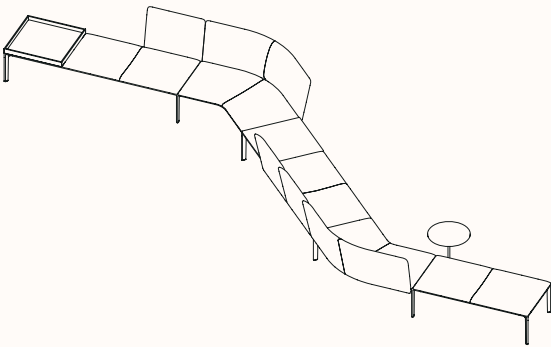

**S-Shape**

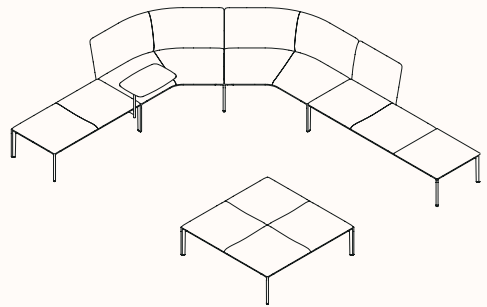

**Big Lounge**

## Configurations

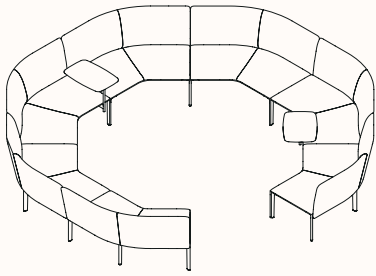

**Round In**

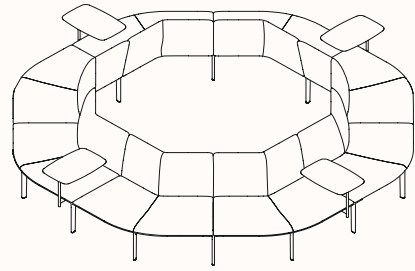

**Round Out**

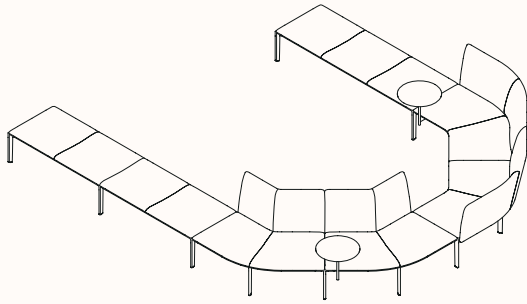

**U-Shape**

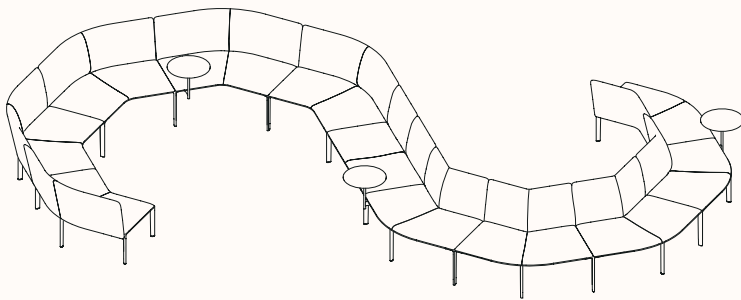

**S-Shape Big**